

TAB 



**OPzS
OGi
UPS
TOPzS
OPzV**

**STATIONARY
BATTERIES**

TAB OPzS

TECHNICAL DATA AND DIMENSIONS

6V 4 OPzS 200

↑ Rated voltage
↑ Number of positive plate
↑ Type of plates
↑ Capacity at 10-hour discharging

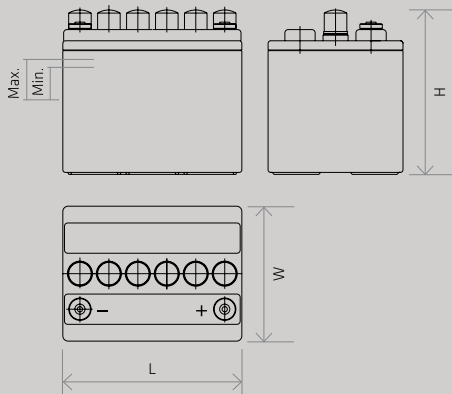

LOW MAINTENANCE TAB OPzS VENTED STATIONARY BATTERIES



TERMINAL POST BOLTED VERSION



TERMINAL POST WELDED VERSION



LET US LEAD YOU INTO THE WORLD OF EVERLASTING ENERGY AND INTRODUCE YOU WITH OPzS STATIONARY BLOCKS AND CELLS PRODUCED IN THE CONVENTIONAL LEAD-ACID TECHNOLOGY.

The batteries are distinguished for:

- » HIGH CAPACITY
- » LONG LIFE TIME
- » REDUCED MAINTENANCE
- » LOW SELF-DISCHARGING
- » QUICK AND SIMPLE ACID LEVEL CONTROL
- » ECONOMICAL WATER CONSUMPTION
- » APPROPRIATE DIMENSIONS AND WEIGHT
- » THE LOWEST AND CONSTANT MAINTENANCE CURRENT.

The individual cells (2V) and blocks (6V and 12V) are in translucent plastic containers made of styrenacrylnitril (SAN), a material which is extraordinary resistant to chemical influences and mechanical damage.

The stationary batteries of the type OPzS are manufactured according to the DIN 40736, EN 60896 and IEC 896-1 regulations.

APPLICATION

Stationary batteries of the OPzS type are intended for the supply of telecommunication facilities, computers, emergency lightning, alarm, control and monitoring systems in power plants and distribution stations, at railway stations, airports etc. Due to their extremely low self-discharging they are suitable for plants supplied by solar cells.

OPERATION MAINTENANCE

IT IS RECOMMENDED THAT THE OPzS BATTERIES ARE INSTALLED IN THE SYSTEMS WHERE THEY ARE CONSTANTLY CONNECTED TO THE RECTIFIER.

The battery can be float-charged with voltage of 2.23 to 2.25 V/cell, or, in case of rapid charging after discharge, with voltage of 2.35 to 2.40 V/cell.

Rapid charging usually lasts another 3-5 hours after the voltage has already reached 2.35 to 2.40 V/cell. After that, an automatic switchover to the constant maintaining voltage of 2.23 to 2.25 V/cell takes place. Battery maintenance is reduced to a minimum and required only from time to time.

AT NORMAL OPERATION, ONLY SOME DESTILLED WATER HAS TO BE ADDED ONCE IN A 2-3 YEAR PERIOD AND, IF NECESSARY, THE SURFACE OF CELLS HAS TO BE CLEANED. ALL STATED VOLTAGE VALUES ARE VALID FOR THE TEMPERATURE RANGE FROM 15 TO 25 DEGREES C. OUT OF THIS RANGE, THE CORRECTIONS GIVEN BY THE BATTERY PRODUCER ARE NECESSARY.

FOR DETAIL INFORMATION PLEASE CHECK OUR OPERATION MANUAL.

ORDERS

IN ORDER THAT THE BATTERIES WOULD MEET ALL YOUR DEMANDS, WE KINDLY ASK YOU TO ENCLOSE THE FOLLOWING DATA WITH YOUR ORDER:

- » kind of **consuming device** (telephone plant, DC-AC converter, emergency lightning etc.)
- » **operating energy** of the consumer (kW, kVA, $\cos \Phi$)
- » minimum and maximum **allowable rated voltage** at consuming device (V)
- » **time diagram** of a consumer load, and the required time autonomy (reserve)
- » **expected voltage drop** in the supply lines
- » **surrounding temperature** in the battery room (average, minimum, maximum)
- » **type of rectifier**, its characteristics, regulating point I (A) or U (V), respectively, float voltage (V) (direct voltage of rapid-charging current I_{max} (A), float charging voltage)
- » **outline** or dimensions of a battery room
- » **type of installation** (welded, bolted, on wooden or metal racks, in case, on earthquake-proof racks)
- » **battery maintenance accessories** (areometers, thermometers, jug ...)
- » **battery type**: filled up with electrolyte and electrically charged or dry-charge battery.

IN CASE OF PROBLEMS WITH ORDERING WE WILL BE GLAD TO ADVISE AND ASSIST YOU IN THE SELECTION OF THE SUITABLE TYPE OF BATTERY.



CONSTRUCTION

The positive armored plate is of a tubular type, which means that the active substance (PbO₂) is contained in special gauntlet made of polyester fibres and hardened by an impregnation compound. Such construction prevents escaping of an active substance during the operation and ensures a long life time. The grids of a positive and a negative plate are made of special low percentage (less than 2 %) antimony alloy with addition agents for improvement of crystalline structure of casting. Negative plates are pasted-type plates with special alloys maintaining porosity of an active substance during the operation. As an electrolyte, a diluted sulphuric acid (H₂SO₄) with a density of 1.24 ± 0.01 kg/l at 20 degrees C, and at a maximum permitted level is used. Separators separating the positive plates from the negative ones are made of microporous plastic material with a low electric resistance. The cell containers are made of transparent SAN, while lid of nontransparent SAN or ABS material (SAN for blocks, ABs for 2V cells). In a special process, the lids are tightly

sealed to the container. The terminal plugs are sealed with rubber seals. This prevents any escape of electrolyte from the cells. Due to the transparent containers the electrolyte level is clearly visible, the maximum and minimum levels are marked on a self-adhesive acid-proof label on a container side. A cell plug seals well (ceramic filter), and prevents leakage of any sulphuric acid vapours, however, it lets through hydrogen and oxygen.

Two versions of batteries are being manufactured:

- » **DRY-CHARGE VERSION:** a battery has to be filled up with an electrolyte and supplementary charged before use. The plates are already formed and in a special process protected against oxidation. They can be stored without problems.
- » **ELECTROLYTE-CHARGE:** battery can be installed immediately, because it is already filled up with electrolyte and electrically charged as well. The capacity test has already been performed by the producer.

IMPROVED DESIGN FOR BOLTED VERSION TERMINAL POST

New type of pole for stationary applications has a **special design** with embraced injected plastic around pre-machined lead part in the sealing area.

PLANE AND CLEAN SURFACE OF PLASTIC PART IN COMBINATION WITH RUBBER SEALING RING ENSURES PERFECT SEAL. LONG PLASTIC INJECTED PART ALLOWS POLE GROWTH AND MOVING UPWARDS BY THE GROWTH OF POSITIVE PLATE. SUCH CONSTRUCTION ENSURES TIGHT POLE BUSHING WITHOUT ANY CORROSION OR DETERIORATION DURING BATTERY LIFE.

TAB OPzS BLOCKS



TAB OPzS STATIONARY BLOCKS (CELLS) ARE PRODUCED IN THE CONVENTIONAL LEAD-ACID TECHNOLOGY.

Stationary batteries of the OPzS type are intended for the supply of telecommunication facilities, computers, emergency lightning, alarm, control and monitoring systems in power plants and distribution stations, at railway stations, airports etc.



DESIGN OPzS cells (block)*

POSITIVE ELECTRODE

» Tubular plate with low antimony alloy (<2 %)

NEGATIVE ELECTRODE

» Flat with long life expander active material

SEPARATION

» Microporous separator

ELECTROLYTE

» Sulphuric acid of 1,24 kg/l at 20 °C

CONTAINER

» High impact, transparent SAN

LID

» ABS (SAN)* in grey color

BLOCKS WITH BLIND CELLS

» 4V, 6V, 8V, 10V

PLUGS

» Ceramic plugs according to DIN 40740

POLE SEALING

» 100 % gas- and electrolyte-tight, sliding-pole

CONNECTOR

» Flexible insulated copper cable with cross-section of 35, 50, 70, 95 or 120 mm² (35, 50 or 70 mm²)*

KIND OF PROTECTION

» IP 25 regarding DIN 40050, touch protected according VBG 4

Uf V/cell	1,80	1,77	1,75	1,67	IEC 896-1		Dimensions (mm)			Weight (kg)		
					RI (mΩ)	Isc (A)	L	W	H	Dry	Wet	
Discharging (h)	10	5	3	1								
CELL TYPE												
12V 1 OPzS 50	51	40,9	38,0	28,4	20,0	613	272	205	392	26	39	
12V 2 OPzS 100	103	81,8	75,7	56,7	9,3	1290	272	205	392	38	50	
12V 3 OPzS 150	154	122,6	113,7	85,1	6,9	1739	380	205	392	53	69	
6V 4 OPzS 200	204	167,0	149,3	115,2	2,2	2703	272	205	392	36	47	
6V 5 OPzS 250	255	208,6	186,6	143,6	1,9	3175	380	205	392	44	61	
6V 6 OPzS 300	307	250,5	223,7	172,0	1,6	3846	380	205	392	52	68	

12V 2 OPzS 100

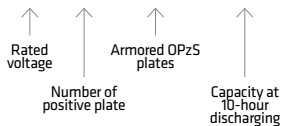

Electrolyte density:
1,24 ± 0,01kg/l at 20 °C.

All measures and weights are within standard production tolerances. Electrical values are approximative. Technical modifications are reserved without prior notice.

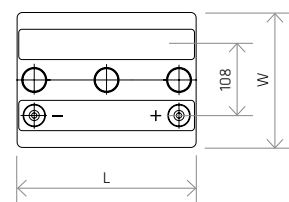
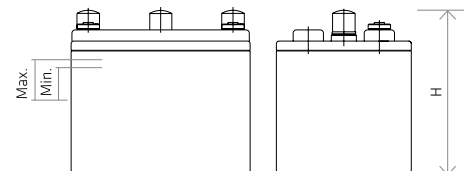
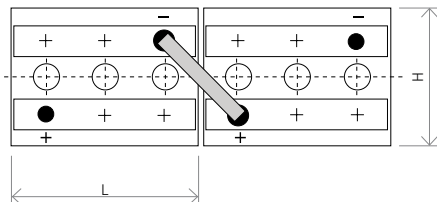
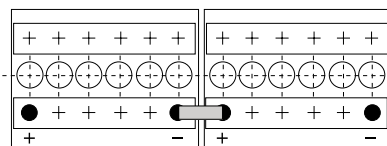

connections

dimensions

TAB OPzS CELLS

CHARGING

OPzS cells (block)*

IU - CHARACTERISTIC

» I_{max} without limitation

FLOAT CHARGE

» U = 2,23 V/cell ± 1 %,
between 10 °C and 30 °C
 $\Delta U/\Delta T = -0,004 \text{ V/K}$
below 10 °C in the monthly average

BOOST CHARGE

» U = 2,35 to 2,40 V/cell, time limited

CHARGING TIME UP TO 92 %

» 6h with 1,5*I₁₀ initial current,
2,23 V/cell, 50 % C₁₀ discharged

DISCHARGE CHARACTERISTICS

OPzS cells (block)*

REFERENCE TEMPERATURE

» 20 °C

INITIAL CAPACITY

» 100 %

DEPTH OF DISCHARGE

» Normally up to 80 %
» More than 80 % DOD or discharges
beyond final discharge voltages
(dependent on discharge current)
have to be avoided

MAINTENANCE

OPzS cells (block)*

EVERY 6 MONTH

» Check battery voltage,
pilot block voltage, temperature

EVERY 12 MONTH

» Take down battery voltage,
block voltage, temperature

OPERATIONAL DATA

OPzS cells (block)*

DESIGN LIFE

» Up to 20 years
(18 years)* at 20 °C

WATER REFILLING INTERVAL

» More than 2 years
at 20 °C

IEC 896-1 CYCLES

» 1500 (1200)*

SELF-DISCHARGE

» Approx. 2 % per
month at 20 °C

OPERATIONAL TEMPERATURE

» -20 °C to 55 °C,
recommended 10 °C
to 30 °C

VENTILATION REQUIREMENT

» f₁=0,5 (low-antimony
alloy) according
EN 50272-2

MEASUREMENTS ACCORDING

» DIN 40 737 part 1

TESTS ACCORDING

» IEC 896-1

SAFETY STANDARDS

» VDE 0510 part 2 and

EN 50272-2

TRANSPORT

» No dangerous goods
during road transport



Uf V/cell	1,80	1,77	1,75	1,67	IEC 896-1		Dimensions (mm)			Weight (kg)		Nº of Poles
	Discharging (h)	10	5	3	1	Ri (mΩ)	Isc (A)	L	W	H	Dry	

CELL TYPE

2 OPzS 100	107	94	82	60	1,48	1350	103	206	420	8,7	13,7	2
3 OPzS 150	155	136	117	86	1,08	1845	103	206	420	11	16	2
4 OPzS 200	208	180	158	115	0,84	2376	103	206	420	13	18	2
5 OPzS 250	259	224	197	144	0,69	3887	124	206	420	16	22	2
6 OPzS 300	310	268	234	171	0,58	3438	145	206	420	18	26	2
5 OPzS 350	380	325	280	205	0,64	3137	124	206	536	20	29	2
6 OPzS 420	454	389	336	245	0,55	3641	145	206	536	24	34	2
7 OPzS 490	532	454	392	286	0,48	4169	166	206	536	28	39	2
6 OPzS 600	640	544	477	348	0,45	4466	145	206	711	35	50	2
8 OPzS 800	853	727	638	466	0,33	6035	210	191	711	46	65	4
10 OPzS 1000	1065	909	796	581	0,26	7720	210	233	711	57	80	4
12 OPzS 1200	1278	1088	954	696	0,23	8814	210	275	711	66	93	4
12 OPzS 1500	1613	1381	1196	873	0,23	8605	210	275	861	88	119	4
16 OPzS 2000	2143	1838	1591	1162	0,17	12042	212	397	837	115	160	6
20 OPzS 2500	2675	2295	1988	1452	0,13	15007	212	487	837	145	200	8
24 OPzS 3000	3208	2752	2382	1739	0,12	17390	212	576	837	170	240	8

Electrolyte density:
1,24 ± 0,01kg/l at 20 °C.

All measures and weights are within
standard production tolerances.
Electrical values are approximative.
Technical modifications are reserved
without prior notice.

3 OPzS 150

↑ Number of positive plate
↑ Armored OPzS plates
↑ Capacity at 10-hour discharging

TAB OGi BATTERIES



TAB OGi BLOCK BATTERIES ARE ROBUST VENTED LEAD-ACID BATTERIES DESIGNED FOR INDUSTRIAL APPLICATIONS IN POWER SUPPLY WITH HIGH SAFETY REQUIREMENTS.

TAB OGi block batteries can be used for both long duration discharge (10 hours) and short duration discharge (few minutes). The main areas of application are DC power supply systems in power stations, UPS systems, industrial systems and emergency power supply systems. They can also be used for engine starting and PV power systems.



Uf V/cell	1,80	1,75	1,75	1,70	1,65	1,65	1,60	IEC 896-1		Dimensions (mm)			Weight (kg)	
Discharging (h)	10	5	3	1	1/2	1/6	1/12	Ri (mΩ)	Isc (kA)	L	W	H	Dry	Wet

CELL TYPE

12V 1 OGi 25	29,0	25,5	22,5	16,8	14,3	9,2	6,7	16,79	0,72	272	205	392	22,0	33,0
12V 2 OGi 50	55,0	49,5	44,7	32,8	28,0	18,0	13,1	8,81	1,41	272	205	392	30,1	41,0
12V 3 OGi 75	80,0	74,5	67,5	49,6	42,2	27,3	19,8	5,94	2,11	272	205	392	38,2	49,0
12V 4 OGi 100	105,0	98,5	89,4	65,7	56,1	36,1	26,1	4,46	2,81	272	205	392	47,3	58,0
12V 5 OGi 125	135,0	123,0	111,3	81,6	69,0	44,3	31,7	3,57	3,52	380	205	392	62,3	78,0
12V 6 OGi 150	165,0	148,5	133,8	98,2	82,5	52,7	37,1	2,97	4,22	380	205	392	70,5	86,0
6V 7 OGi 175	187,2	167,3	151,3	110,7	91,2	56,9	39,6	1,27	4,93	272	205	392	37,7	49,0
6V 8 OGi 200	228,0	197,5	178,8	130,0	108,0	67,3	46,8	1,11	5,63	272	205	392	41,9	53,0
6V 9 OGi 225	254,0	221,5	200,7	145,8	121,5	75,5	52,6	0,99	6,36	380	205	392	51,6	68,0
6V 10 OGi 250	270,0	247,0	223,5	161,7	133,0	80,5	55,3	0,89	7,04	380	205	392	55,7	72,0
6V 11 OGi 275	304,0	271,5	245,1	177,6	146,0	88,5	60,7	0,81	7,78	380	205	392	58,8	75,0
6V 12 OGi 300	320,0	296,0	268,2	194,4	159,5	96,5	66,3	0,74	8,44	380	205	392	63,0	79,0
2V 3 OGi 75	80,0	74,5	67,5	49,6	42,2	27,3	19,8	0,99	2,11	103	206	420	9,1	13,8
2V 4 OGi 100	105,0	98,5	89,4	65,7	56,1	36,1	26,1	0,74	2,81	103	206	420	10,0	14,5
2V 5 OGi 125	135,0	123,0	111,3	81,6	69,0	44,3	31,7	0,60	3,52	103	206	420	10,9	15,2
2V 6 OGi 150	165,0	148,5	133,8	98,2	82,5	52,7	37,1	0,50	4,22	103	206	420	11,8	15,9
2V 7 OGi 175	187,2	167,3	151,3	110,7	91,2	56,9	39,6	0,42	4,93	103	206	420	12,6	16,5
2V 8 OGi 200	228,0	197,5	178,8	130,0	108,0	67,3	46,8	0,37	5,63	103	206	420	13,4	17,1
2V 9 OGi 225	254,0	221,5	200,7	145,8	121,5	75,5	52,6	0,33	6,36	103	206	420	14,2	17,7
2V 10 OGi 250	270,0	247,0	223,5	161,7	133,0	80,5	55,3	0,30	7,04	126	206	420	14,3	20,5
2V 11 OGi 275	304,0	271,5	245,1	177,6	146,0	88,5	60,7	0,27	7,78	145	206	420	16,1	23,3
2V 12 OGi 300	320,0	296,0	268,2	194,4	159,5	96,5	66,3	0,25	8,44	145	206	420	17,5	24,5
2V 24 OGi 600	684,0	592,5	536,4	390,0	324,0	201,9	140,4	0,13	16,42	205	272	392	41,9	53,0
2V 30 OGi 750	810,0	741,0	670,5	485,1	399,0	241,5	165,9	0,1	21,89	205	380	392	55,7	72,0
2V 36 OGi 900	960,0	888,0	804,6	583,2	478,5	289,5	198,9	0,08	24,63	205	380	392	63,0	79,0

DESIGN

POSITIVE ELECTRODE

- » Robust-grid plate with circular bars in a corrosion-resistant PbSe alloy < 2 % Sb

NEGATIVE ELECTRODE

- » Flat plate with long life expander and low antimony alloy

SEPARATION

- » Microporous separator

ELECTROLYTE

- » Sulphuric acid of 1,24 kg/l,

CONTAINER

- » High impact, transparent SAN

LID

- » SAN in dark grey colour

BLOCKS WITH BLIND CELLS

- » 4V, 6V, 8V, 10V

PLUGS

- » Ceramic plugs or optional ceramic funnel plugs according to DIN 40740

POLE SEALING

- » 100 % gas-and electrolyte-tight, sliding-pole

POLE

- » M10, brass insert

CONNECTOR

- » Flexible insulated copper cable, with cross-section of 35, 50, 70, 95 or 120 mm²

KIND OF PROTECTION

- » IP 25 regarding DIN 40050, touch protected according VBG 4

CHARGING

IU - CHARACTERISTIC

- » I_{max} without limitation

FLOAT CHARGE

- » U = 2,23 V/cell ± 1 %, between 10 °C and 55 °C
dU/dT = -0,004 mV/°K below 10 °C in the monthly average

BOOST CHARGE

- » U = 2,35 to 2,40V/cell, time limited

CHARGING TIME UP TO 92 %

- » 6h with 1,5*10 initial current, 2,23 V/cell, 50 % C10 discharged

DISCHARGE CHARACTERISTICS

REFERENCE TEMPERATURE

- » 20 °C

INITIAL CAPACITY

- » 100 %

DEPTH OF DISCHARGE

- » Normally up to 80 %
- » More than 80 % DOD or discharges beyond final discharge voltages (dependent on discharge current) have to be avoided

MAINTENANCE

EVERY 6 MONTH

- » Check battery voltage, pilot block voltage, temperature

EVERY 12 MONTH

- » Take down battery voltage, block voltage, temperature

OPERATIONAL DATA

OPERATIONAL LIFE

- » Up to 15 years at 20 °C
- » Up to 7,5 years at 30 °C
- » Up to 4 years at 40 °C

WATER REFILLING INTERVAL

- » More than 3 years at 20 °C

IEC 896-1 CYCLES

- » 1000

SELF-DISCHARGE

- » Approx. 3 % per month at 20 °C

OPERATIONAL TEMPERATURE

- » -20 °C to 55 °C, recommended 10 °C to 30 °C

VENTILATION REQUIREMENT

- » f1=0,5 (low-antimony alloy) according VDE 0510 part 2

MEASUREMENTS ACCORDING

- » DIN 40 737 part 3

TESTS ACCORDING

- » IEC 896-1

APPLICABLE STANDARDS

- » VDE 0510 part 2

TRANSPORT

- » No dangerous goods during road transport

6V 7 OGi 175

- ↑ Rated voltage
- ↑ Number of positive plate
- ↑ Robust OGi plates
- ↑ Capacity at 10-hour discharging

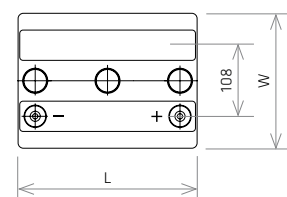
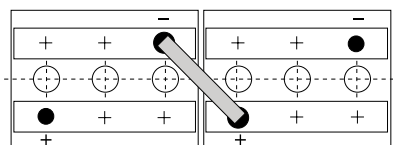
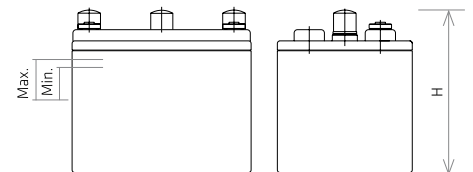
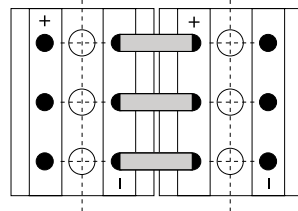
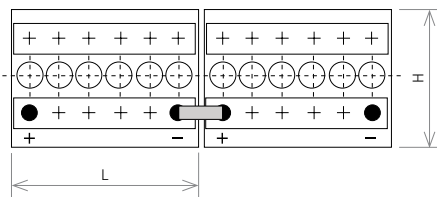

- « Electrolyte density: 1,24 ± 0,01kg/l at 20 °C.

All measures and weights are within standard production tolerances. Electrical values are approximative. Technical modifications are reserved without prior notice.

connections

dimensions

TAB UPS BATTERIES



TAB UPS BATTERIES ARE ROBUST AND FOR HIGH DISCHARGE - PERFORMANCES OPTIMISED LEAD-ACID BATTERIES.

The main application for TAB UPS are Uninterruptable Power Supplies (UPS) in the size of 50 to 250 kVA. The battery is perfectly suited to start diesel engines for the auxiliary power supply.



Uf V/cell	1,80	1,75	1,70	1,65	1,63	1,60	IEC 896-1		Dimensions (mm)			Weight (kg)	
							Ri (mΩ)	Isc (kA)	L	W	H	Dry	Wet
Discharging (min)		60	30	15	10	5							
CELL TYPE	C10(Ah)	W/CELL											
12V 1 UPS 100	41	42	64	92	120	181	16,8	0,73	272	205	392	22,0	33
12V 2 UPS 200	59	73	112	169	218	323	8,4	1,46	272	205	392	30,1	41
12V 3 UPS 300	86	103	162	246	313	465	5,6	2,2	272	205	392	38,2	49
12V 4 UPS 400	114	135	210	322	410	606	4,2	2,93	272	205	392	47,3	58
12V 5 UPS 500	147	169	264	412	520	755	3,36	3,66	380	205	392	62,3	78
12V 6 UPS 600	179	204	327	500	629	895	2,8	4,39	380	205	392	70,5	86
6V 7 UPS 700	206	237	384	588	737	1040	1,2	5,13	272	205	392	37,1	49
6V 8 UPS 800	247	272	440	676	848	1187	1,05	5,86	272	205	392	41,9	53
6V 9 UPS 900	271	306	492	742	913	1294	0,93	6,59	380	205	392	52,0	68
6V 10 UPS 1000	293	342	558	812	1014	1403	0,84	7,32	380	205	392	57,0	72
6V 11 UPS 1100	325	381	592	879	1098	1509	0,76	8,05	380	205	392	59,0	75
6V 12 UPS 1200	347	418	640	946	1178	1613	0,7	8,79	380	205	392	63,0	86
2V 24 UPS 2400	742	816	1321	2027	2544	3562	0,13	17,58	205	272	392	41,9	53
2V 30 UPS 3000	879	1027	1674	2437	3042	4209	0,1	21,9	205	380	392	57,0	72
2V 36 UPS 3600	1041	1253	1920	2837	3535	4838	0,08	26,3	205	380	392	63,0	86

100 W is the average power per plate at the 10 min rate Uf=1,63.

Electrolyte density: 1,28 ± 0,01 kg/l at 20 °C.

All measures and weights are within standard production tolerances. Electrical values are approximative. Technical modifications are reserved without prior notice.

DESIGN

POSITIVE ELECTRODE

- » Robust-plate with circular bars in a corrosion-resistant PbSe alloy < 2 % Sb

NEGATIVE ELECTRODE

- » Flat plate with long life expander and low antimony alloy

SEPARATION

- » Microporous separator

ELECTROLYTE

- » Sulphuric acid of 1,28 kg/l

CONTAINER

- » High impact, transparent SAN

LID

- » SAN in dark grey colour

BLOCKS WITH BLIND CELLS

- » 4V, 6V, 8V, 10V

PLUGS

- » Ceramic plugs or optional ceramic funnel plugs according to DIN 40740

POLE SEALING

- » 100 % gas-and electrolyte-tight, sliding-pole

POLE

- » M10, brass insert

CONNECTOR

- » Flexible insulated copper cable, with cross-section of 35, 50, 70, 95 or 120 mm²

KIND OF PROTECTION

- » IP 25 regarding DIN 40050, touch protected according VBG 4

CHARGING

IU - CHARACTERISTIC

- » I_{max} without limitation

FLOAT CHARGE

- » U = 2,25 to 2,27 V/cell ± 1 %, between 10 °C and 55 °C
dU/dT = -0,004 mV/°K below 10 °C in the monthly average

BOOST CHARGE

- » U = 2,35 to 2,40 V/cell, time limited

CHARGING TIME UP TO 92 %

- » 6h with 1,5*10 initial current, 2,23 V/cell, 50 % C₁₀ discharged

DISCHARGE CHARACTERISTICS

REFERENCE TEMPERATURE

- » 20 °C

INITIAL CAPACITY

- » 100 %

DEPTH OF DISCHARGE

- » Normally up to 80 %
- » More than 80 % DOD or discharges beyond final discharge voltages (dependent on discharge current) have to be avoided

MAINTENANCE

EVERY 6 MONTH

- » Check battery voltage, pilot block voltage, temperature

EVERY 12 MONTH

- » Take down battery voltage, block voltage, temperature

OPERATIONAL DATA

OPERATIONAL LIFE

- » Up to 12 years at 20 °C
- » Up to 6 years at 30 °C
- » Up to 3 years at 40 °C

WATER REFILLING INTERVAL

- » More than 3 years at 20 °C

IEC 896-1 CYCLES

- » 800

SELF-DISCHARGE

- » Approx. 3 % per month at 20 °C

OPERATIONAL TEMPERATURE

- » -20 °C to 55 °C, recommended 10 °C to 30 °C

VENTILATION REQUIREMENT

- » f₁=0,5 (low-antimony alloy) according VDE 0510 part 2

MEASUREMENTS ACCORDING

- » DIN 40 737 part 3

TESTS ACCORDING

- » IEC 896-1

APPLICABLE STANDARDS

- » VDE 0510 part 2

TRANSPORT

- » No dangerous goods during road transport

6V 7 UPS 700

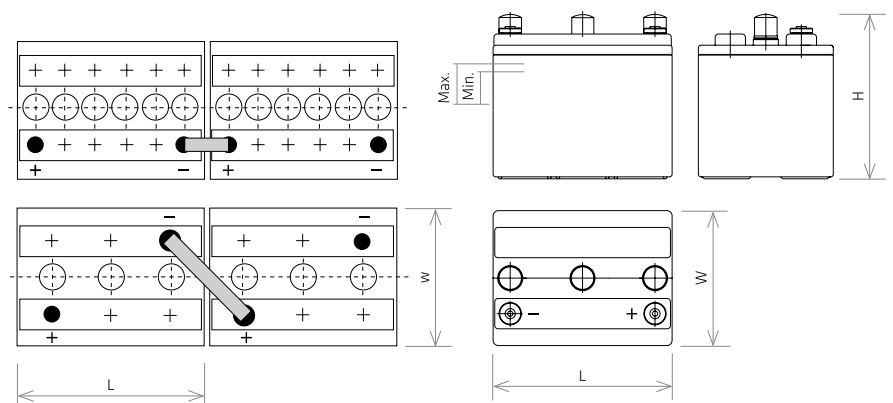
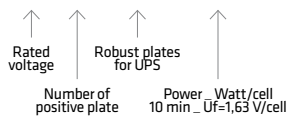

connections

dimensions

TAB TOPzS BATTERIES



LOW MAINTENANCE TAB TOPzS VENTED STATIONARY BATTERIES



The batteries are distinguished for:

- » HIGH CAPACITY
- » LONG LIFE TIME
- » REDUCED MAINTENANCE
- » LOW SELF-DISCHARGING
- » QUICK AND SIMPLE ACID LEVEL CONTROL
- » ECONOMICAL WATER CONSUMPTION
- » APPROPRIATE DIMENSIONS AND WEIGHT
- » THE LOWEST AND CONSTANT MAINTENANCE CURRENT.

The stationary batteries of the type TOPzS are manufactured according to the DIN 40736, EN 60896 and IEC 896-1 regulations. Individual cells (2V) are made from translucent PP containers. The stationary batteries of the type OPzS are manufactured according to the DIN 40736, EN 60896 and IEC 896-1 regulations.

APPLICATION

Stationary batteries of the TOPzS type are specially designed for solar systems. Due to their extremely low self-discharging and tubular positive plates they are suitable for off-grid solar systems.

CONSTRUCTION

The positive armored plate is of a tubular type, which means that the active substance (PbO_2) is contained in special gauntlet made of polyester fibres and hardened by an impregnation compound. Such construction prevents escaping of an active substance during the operation and ensures a long life time.

The grids of a positive and a negative plate are made of special low percentage (less than 2 %) antimony alloy with addition agents for improvement of crystalline structure of casting. Negative plates are pasted-type plates with special alloys maintaining porosity of an active substance during the operation.

As an electrolyte, a diluted sulphuric acid (H_2SO_4) with a density of 1.24 ± 0.01 kg/l at 20 degrees C, and at a maximum permitted level is used. Separators separating the positive plates from the negative ones are made of microporous plastic material with a low electric resistance.

In a special process, the lids are tightly sealed with thermo welding to the container. The terminal plugs are sealed with rubber seals. This prevents any escape of electrolyte from the cells.

Due to the transparent containers the electrolyte level is clearly visible, the maximum and minimum levels are marked on a self-adhesive acid-proof label on a container side.

Two versions of batteries are being manufactured:

» DRY-CHARGE VERSION:

a battery has to be filled up with an electrolyte and supplementary charged before use. The plates are already formed and in a special process protected against oxidation. They can be stored without problems.

» ELECTROLYTE-CHARGE:

battery can be installed immediately, because it is already filled up with electrolyte and electrically charged as well. The capacity test has already been performed by the producer.

DESIGN

POSITIVE ELECTRODE

- » Tubular positive plate with low antimony alloy (<2 %)

NEGATIVE ELECTRODE

- » Flat plate with long life expander

SEPARATION

- » Microporous separator

ELECTROLYTE

- » Sulphuric acid of 1,24 kg/l

CONTAINER

- » Transparent PP

LID

- » PP in green colour

POLE SEALING

- » 100 % gas-and electrolyte-tight, rubber seal

POLE

- » M10, brass insert

CONNECTOR

- » flexible insulated copper cable, with cross-section of 35, 50, or 70 mm²

POLE SCREW

- » M10, steel, insulated

CHARGING

IU - CHARACTERISTIC

- » I_{max} without limitation

FLOAT VOLTAGE

- » U = 2,23 V/cell ± 1 %

BOOST CHARGE

- » U = 2,35 to 2,40 V/cell

DISCHARGE CHARACTERISTICS

REFERENCE TEMPERATURE

- » 20 °C at C10 (1,80 V/cell) and 25 °C at C100 (1,85 V/cell)

INITIAL CAPACITY

- » 100 %

DEPTH OF DISCHARGE

- » Normally up to 80 %
- » More than 80 % DOD or discharges beyond final discharge voltages (dependent on discharge current) have to be avoided

MAINTENANCE

EVERY 6 MONTH

- » Check battery voltage pilot block voltage, temperature

EVERY 12 MONTH

- » Take down battery voltage block voltage, temperature

OPERATIONAL DATA

OPERATIONAL LIFE

- » Up to 15 years

IEC 896-1 CYCLES

- » 1200

SELF-DISCHARGE

- » Approx. 3 % per month at 20 °C

OPERATIONAL TEMPERATURE

- » -20 °C to 55 °C, recommended 10 °C to 30 °C

TESTS ACCORDING

- » IEC 896-1, EN 60896-1, EN 61427

SAFETY STANDARD, VENTILATION

- » EN 50272-2

CELL TYPE	Dimensions (mm)			Weight (kg)		C10	C100
	L	W	H	Dry	Wet	Ah	Ah
3 TOPzS 265	198	83	472	12,4	18,4	265	345
4 TOPzS 353	198	101	472	16,0	23,3	353	458
5 TOPzS 442	198	119	472	20,2	29,0	442	575
4 TOPzS 500	198	101	720	24,3	35,2	500	650
5 TOPzS 625	198	119	720	30,3	43,2	625	812
6 TOPzS 750	198	137	720	38,0	53,5	750	975
7 TOPzS 875	198	173	720	44,0	64,2	875	1137
8 TOPzS 1000	198	191	720	50,2	72,5	1000	1300

Electrolyte density: 1,24 ± 0,01kg/l at 20 °C.

OPERATION-MAINTENANCE

For more detail information please check our operation manual.

TRANSPORT

Batteries are not subject to ADR (road transport).

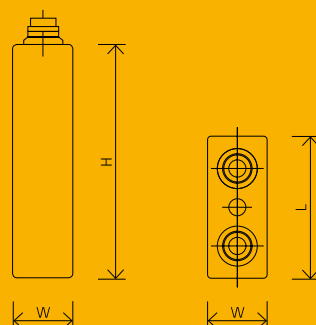
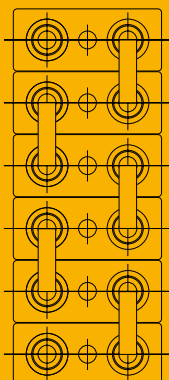

connections

dimensions

TAB OPzV BATTERIES

TAB OPzV range of valve regulated lead acid stationary batteries combine the benefits of recombination technology (i. e. virtually no maintenance due to very low gas emissions) plus the advantages of conventional vented batteries with positive tubular plates (i. e. long life and excellent cycling capability).

TAB OPzV VALVE REGULATED LEAD ACID BATTERIES ARE THE IDEAL ENERGY SOURCE FOR MANY DIFFERENT STANDBY APPLICATIONS.



DESIGN

TUBULAR POSITIVE PLATES

» Special grid construction, pressure cast from antimony free alloy, with highly porous gauntlets that retain the active material

PASTED NEGATIVE PLATES

» Service lives consistent with the positive plates

ELECTROLYTE

» Gel structure

SEPARATORS

» Extremely high porosity and low internal resistance

CONTAINERS AND LIDS

» Made of plastic (ABS) material. Also available in ABS flame retardant material as an option (according to IEC 707 FV0)

TERMINALS

» Female treated terminal (M10) perfect contact and low resistance with flexible cable connectors

» Prevents electrolyte leakage and terminal corrosion

CONNECTORS

» Flexible, fully insulated cable connectors screwed (with 20 ± 1 Nm) to the terminal with an insulated screw having a probe hole on the top for electrical measurement

ONE WAY RELIEF VALVE

» Opens at low pressure and is fitted with a flame arrester device

INSTALLATION

CELLS ARE NORMALLY INSTALLED IN AN UPRIGHT POSITION ON STEEL STANDS

CHARGING

FLOAT VOLTAGE

» Standby use 2.25 V/cell

BOOST RECHARGE

» Maximum voltage of 2.35 - 2.40 V/cell with a maximum current of 0.25 C10 (A)

OPERATIONAL DATA

OPERATIONAL LIFE

» More than 15 years

IEC 896-1 CYCLES

» 1200

SELF-DISCHARGE

» Approx. 2 % per month at 20 °C

TESTS ACCORDING

» IEC 896-1, EN 60896-1, EN 61427

DIN 40742	Capacity (Ah at 20 °C)					Weight	Dimensions (mm)			Isc	Ri	Pict.
	Nomin. Cap.	10 hrs to	5 hrs to	3 hrs to	1 hrs to		L	W	H1/H2			
	10 hrs / 1,8 VPC	1,8 VPC	1,77 VPC	1,75 VPC	1,67 VPC							
4 OPzV 200	200	204	172	150	106	19	103	206	354/380	1660	1,22	A
5 OPzV 250	250	255	215	188	133	23	124	206	354/380	2080	0,98	A
6 OPzV 300	300	306	258	225	159	28	145	206	354/380	2490	0,85	A
5 OPzV 350	350	357	300	263	185	31	124	206	471/496	2770	0,75	A
6 OPzV 420	420	429	360	315	222	36	145	206	471/496	3350	0,61	A
7 OPzV 490	490	500	420	368	259	41	166	206	471/496	3900	0,52	A
6 OPzV 600	600	612	516	450	312	49	145	206	643/668	4060	0,51	A
8 OPzV 800	800	816	688	600	416	65	210	191	664/669	5390	0,38	B
10 OPzV 1000	1000	1020	860	750	520	80	210	233	646/671	6760	0,30	B
12 OPzV 1200	1200	1251	1032	900	624	93	210	275	665/670	8120	0,26	B
12 OPzV 1500	1500	1530	1260	1116	744	115	210	275	796/821	8810	0,23	B
16 OPzV 2000	2000	2040	1680	1488	992	155	214	399	771/796	11510	0,17	C
20 OPzV 2500	2500	2550	2100	1860	1240	200	214	487	769/794	14400	0,14	D
24 OPzV 3000	3000	3060	2520	2232	1488	235	214	576	771/796	17260	0,12	D

According to DIN 40742, IEC 60896-2

FEATURES

- » SAFE
- » VERSATILE
- » RELIABLE
- » MINIMAL GASSING
- » DEEP DISCHARGE RESISTANCE

